

INSTALLATION INSTRUCTION
TAILGATE POWER LOCK FOR MITSUBISHI TRITON 2023

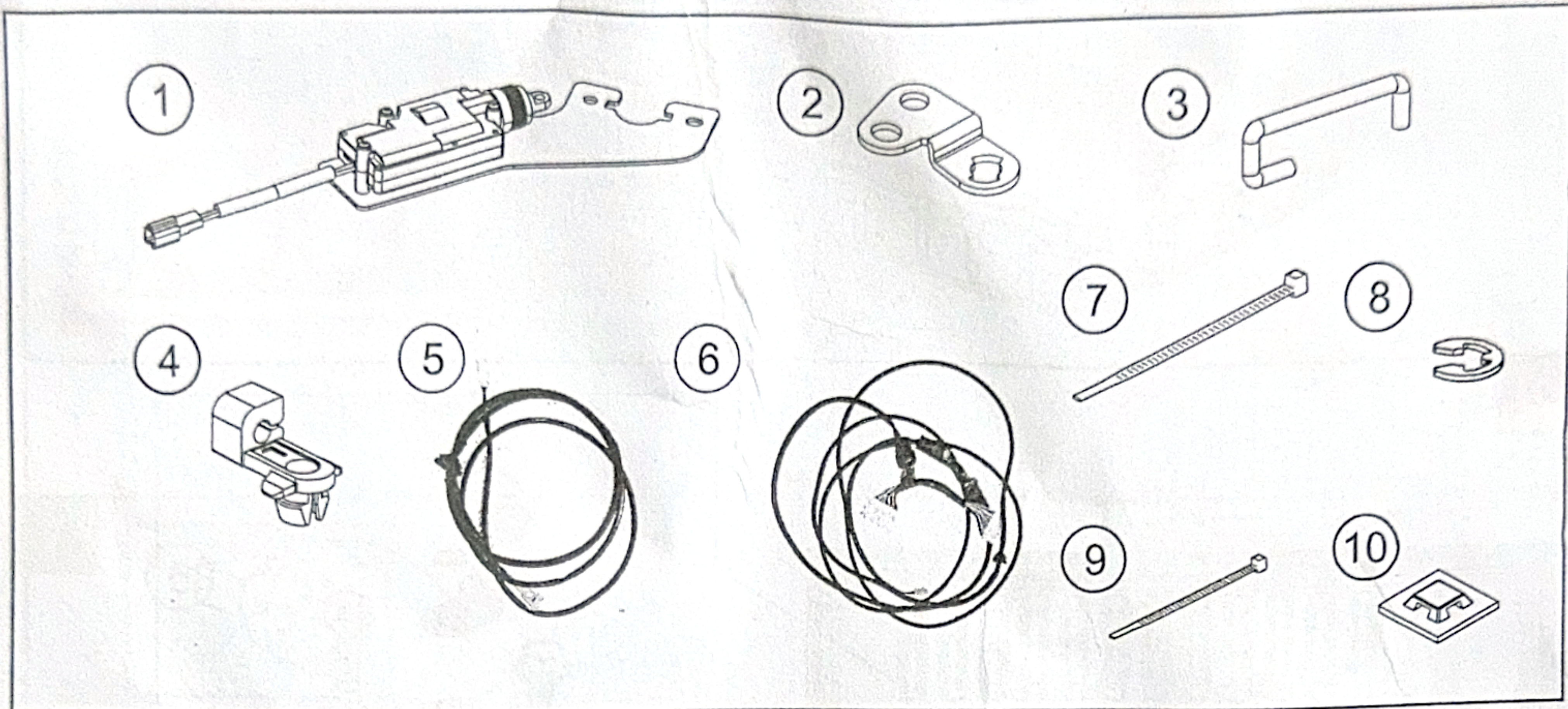
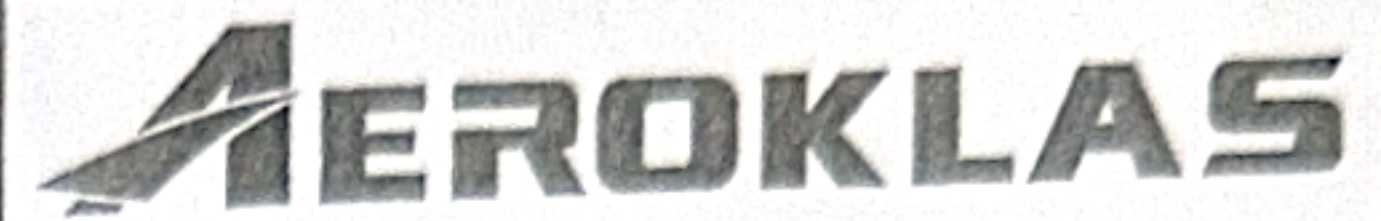
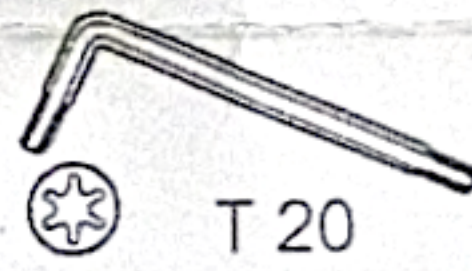

หมายเลข No.	ชื่ออะไหล่ Part Name	หมายเลขอะไหล่ Part No.	จำนวน Qty
1.	ACTUATOR	-	1
2.	BRACKET LOOK-UNLOOK	-	1
3.	LINK	-	1
4.	CLIP LOCK ARM LH	-	1
5.	WIRE HARNESS 1	-	1
6.	WIRE HARNESS 2	-	1
7.	CABLE TIE L 610 mm.	-	5
8.	E- RING	-	1
9.	CABLE TIE L 100 mm.	-	5
10.	MOUNTING BASE	-	5

เครื่องมือ/TOOLS
 No. 10
 T 20

1

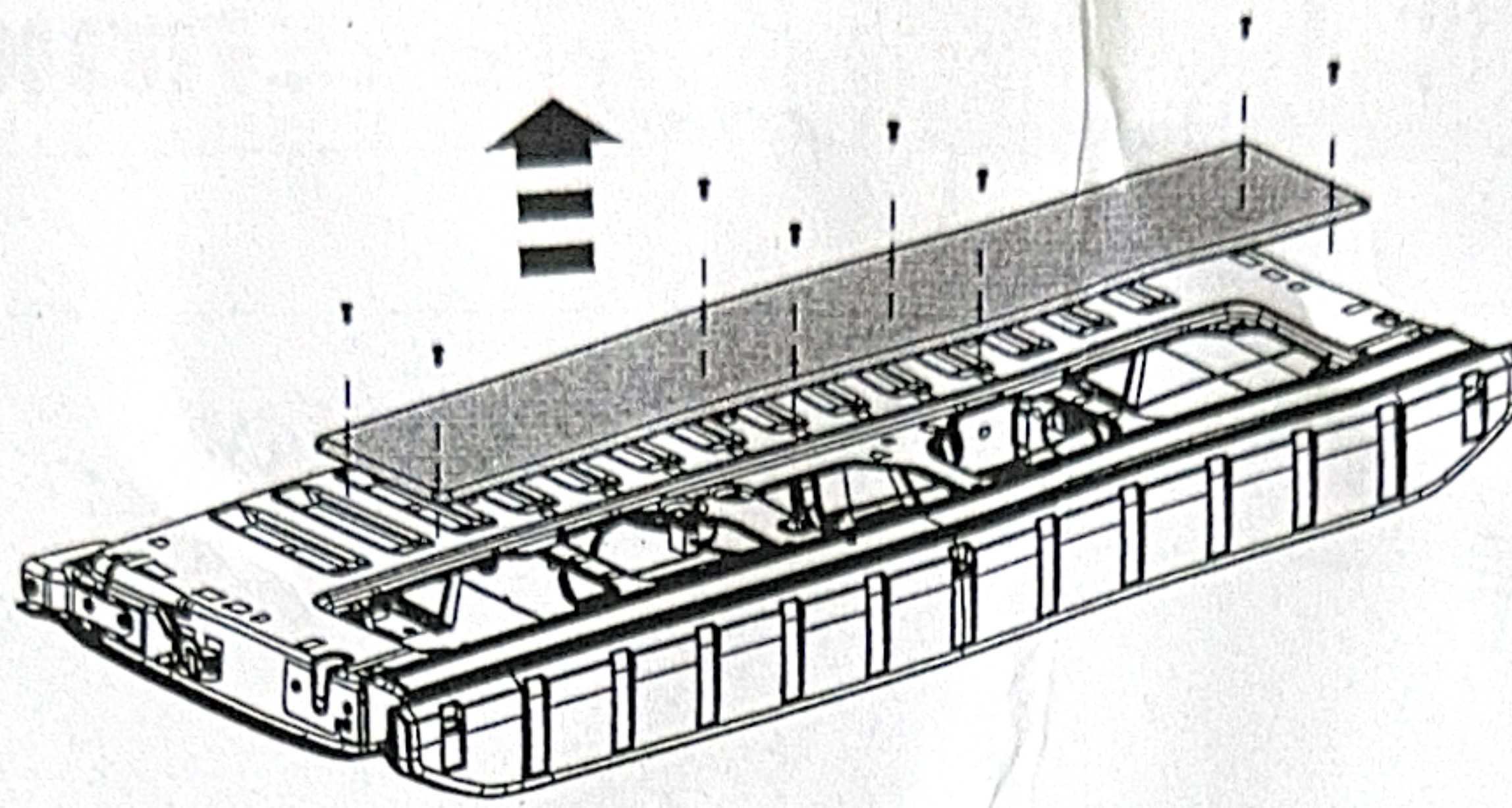

2

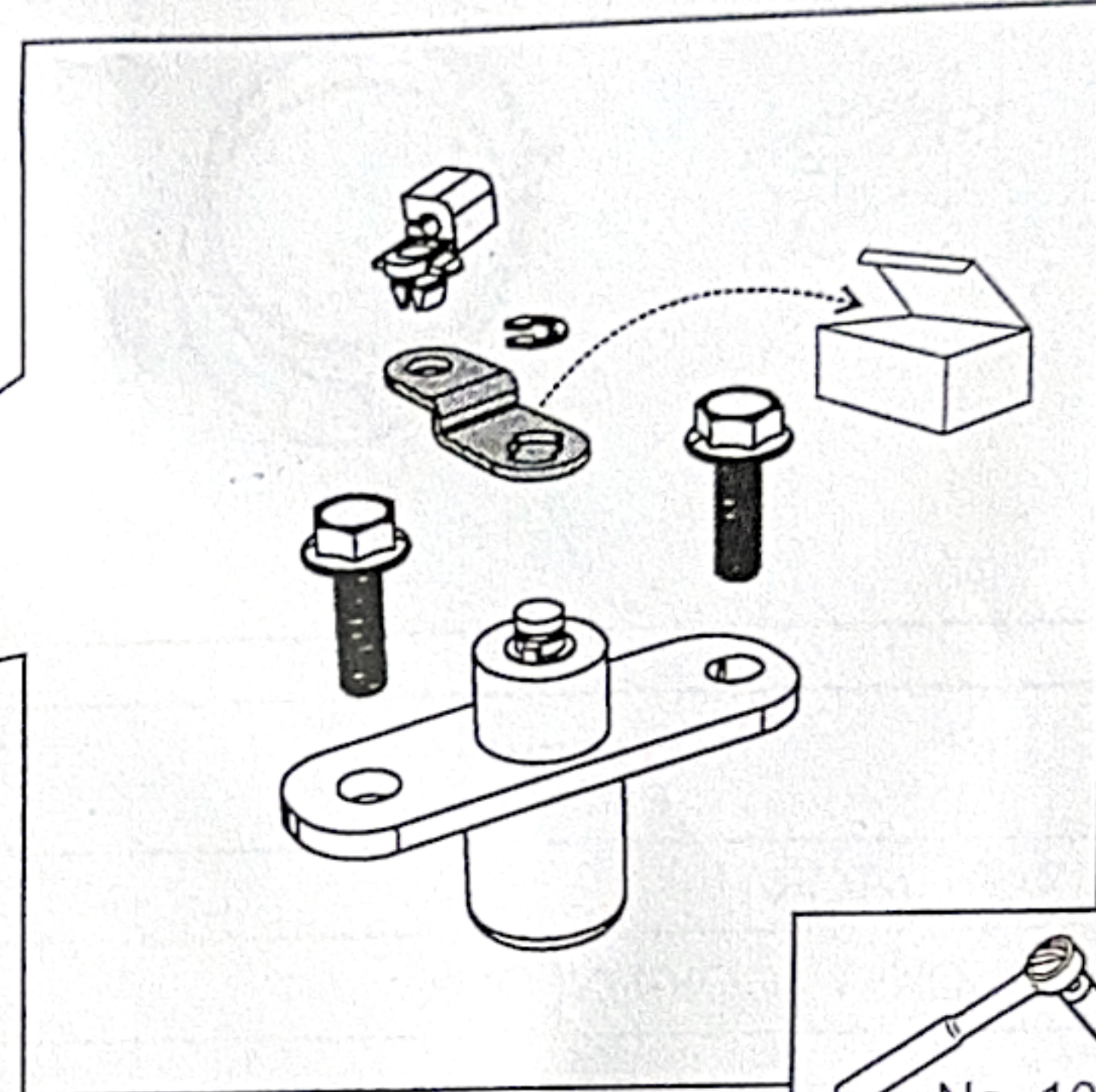
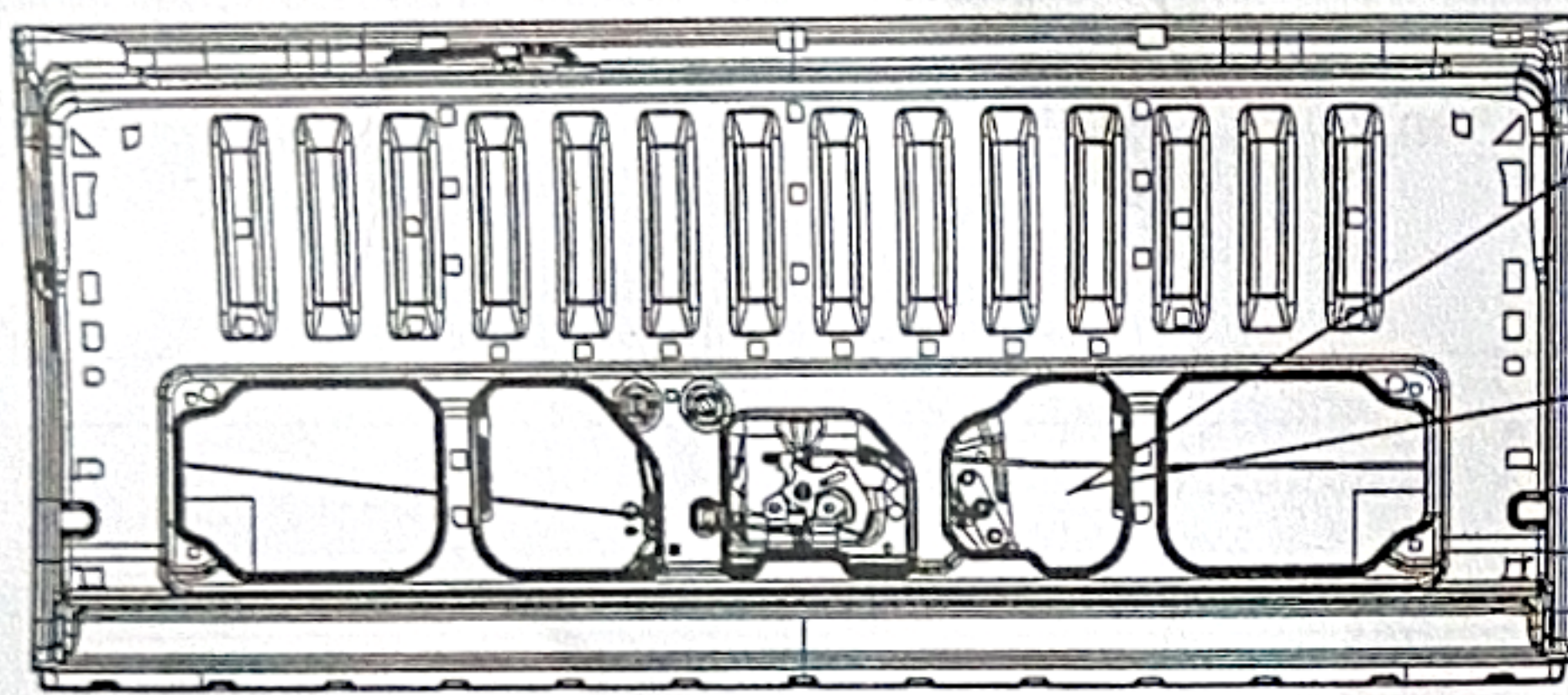

3

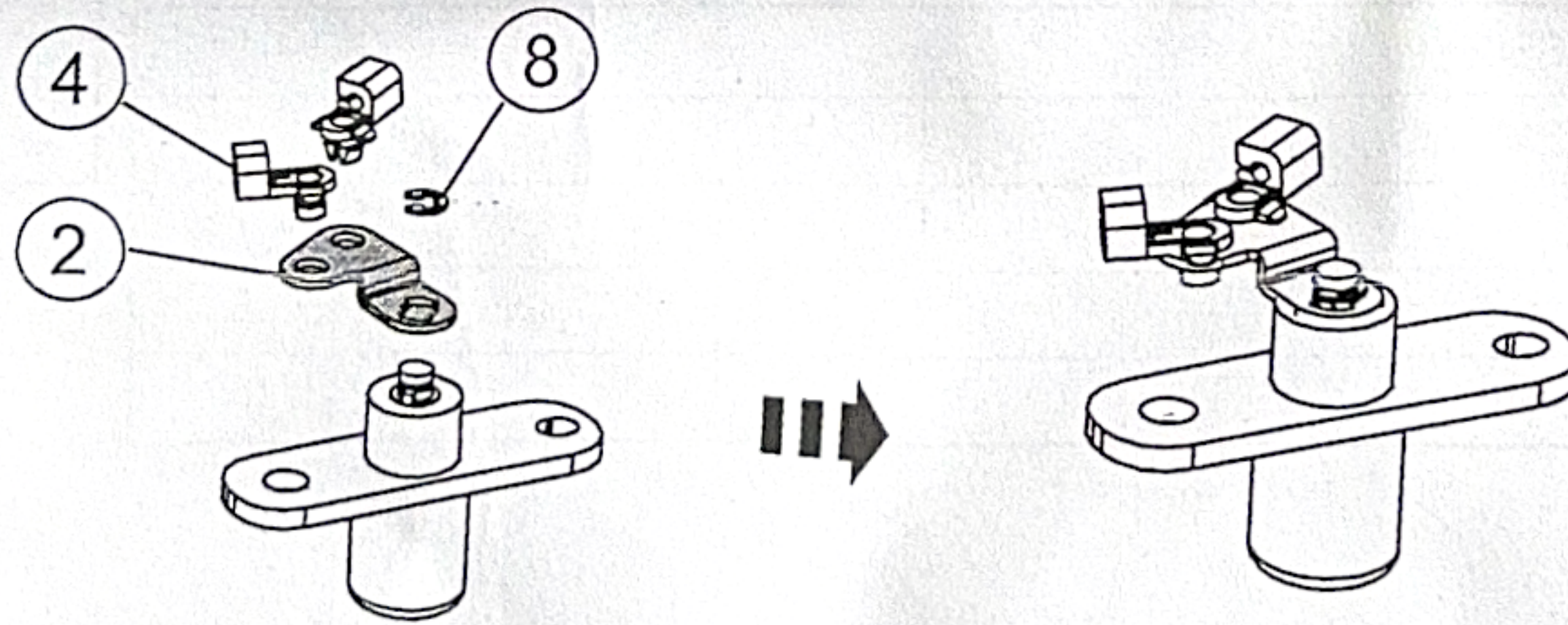

4

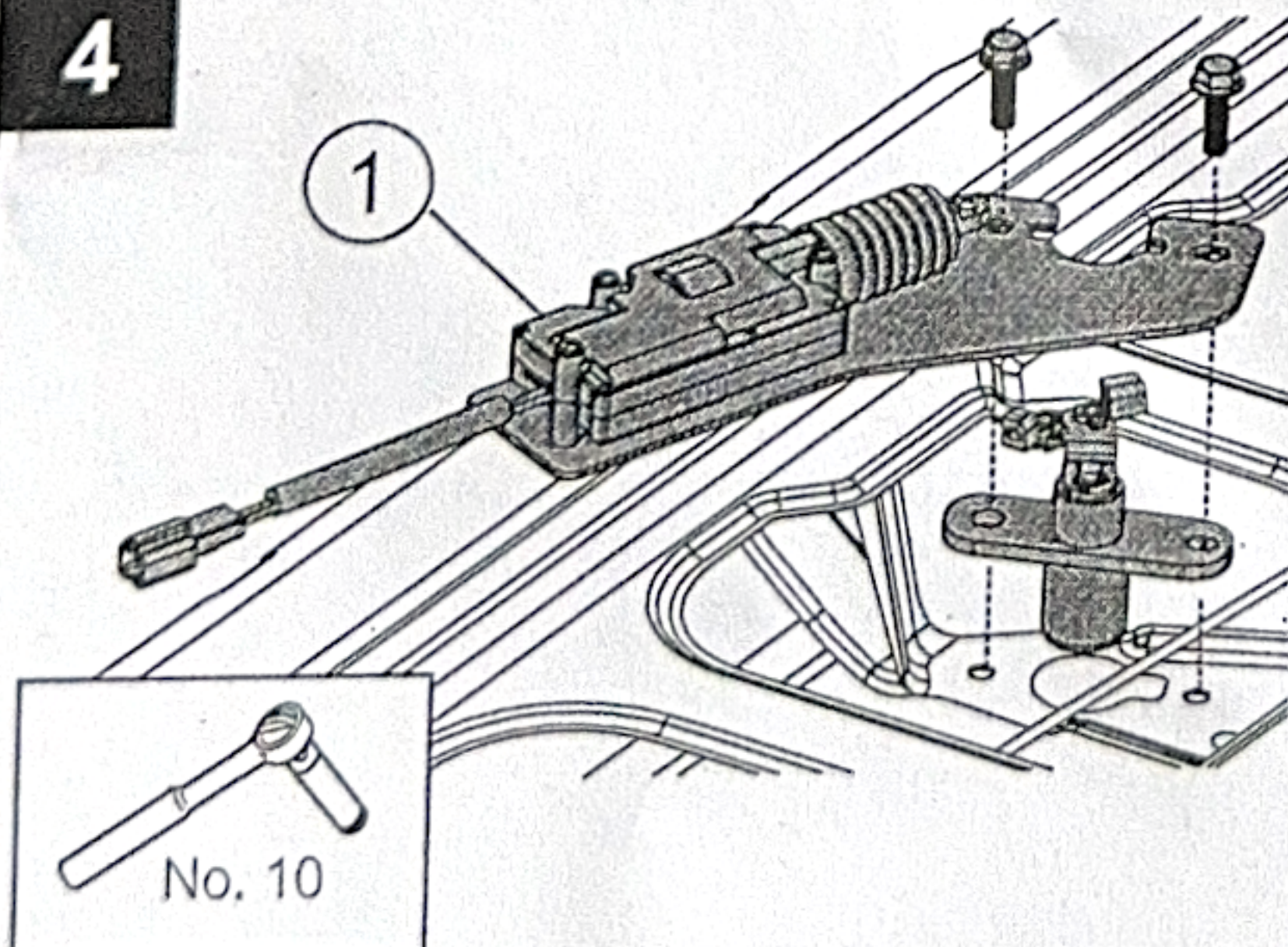

5

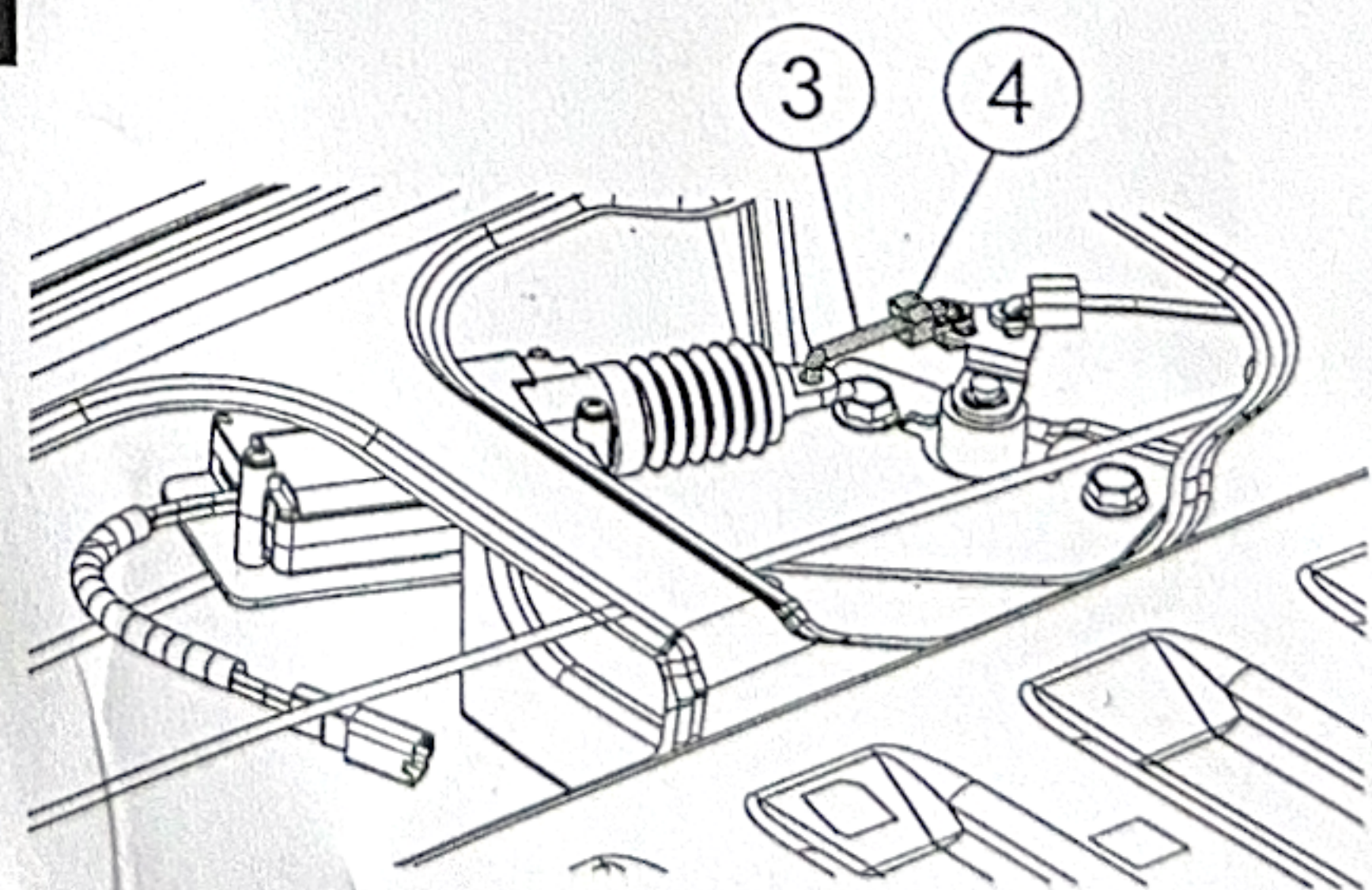

6

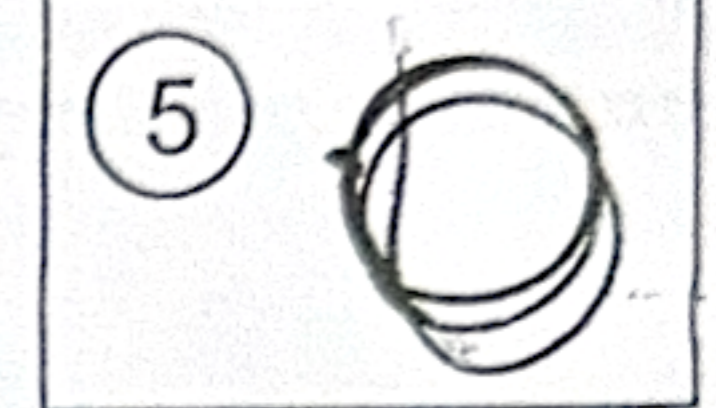
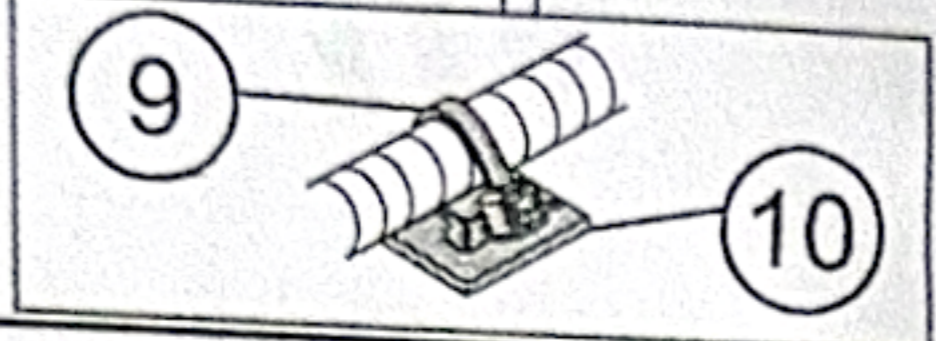
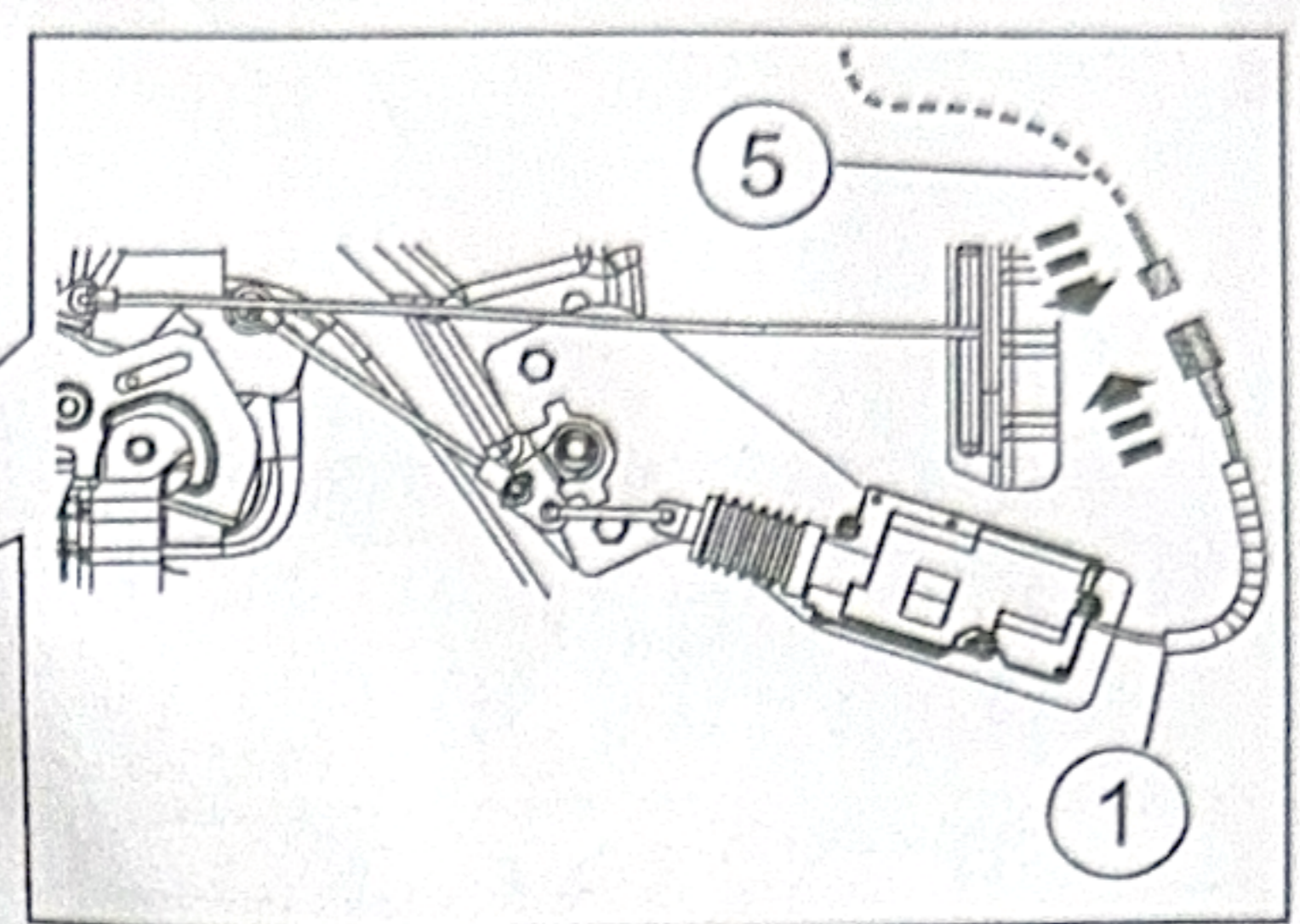
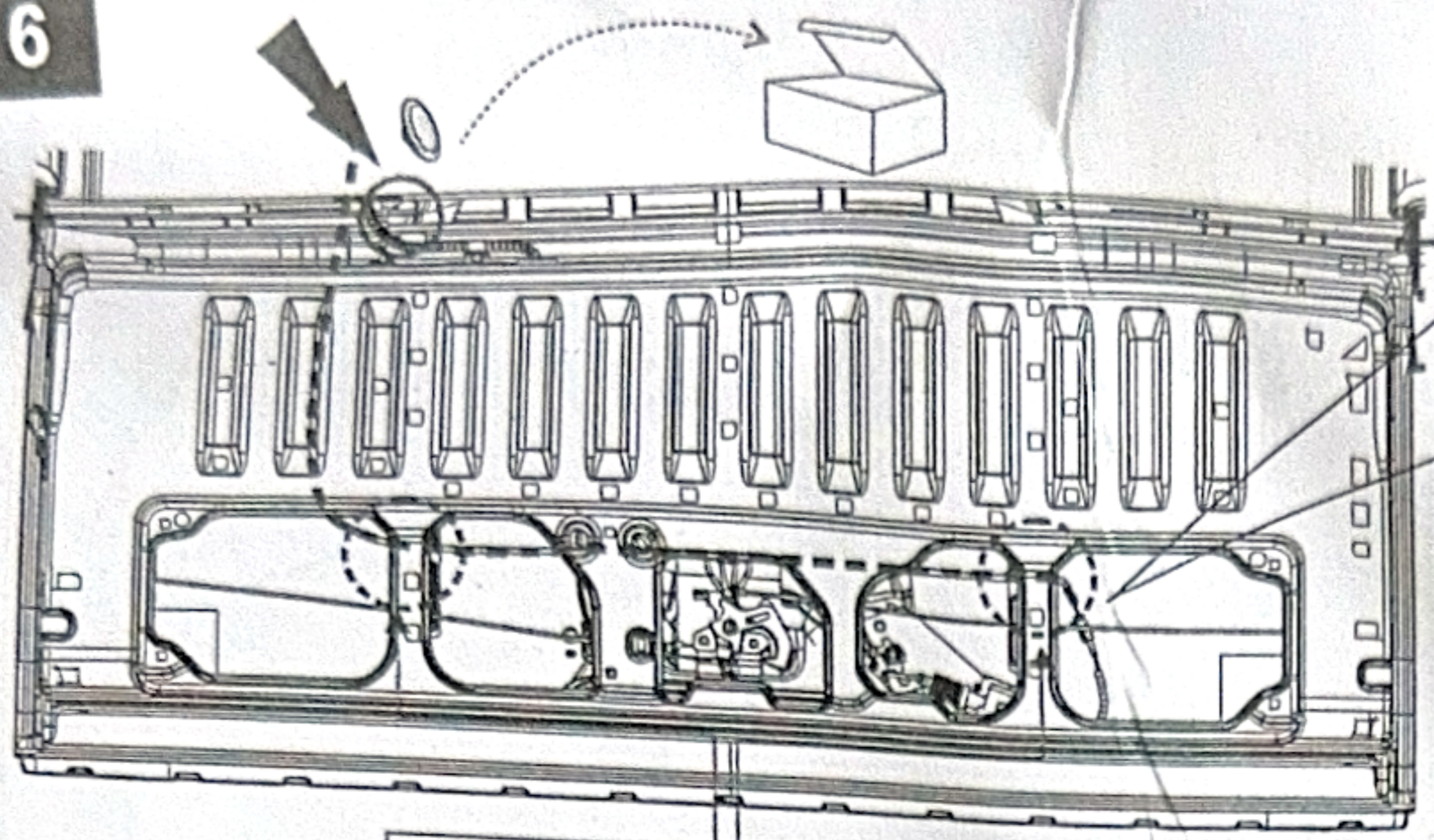

7

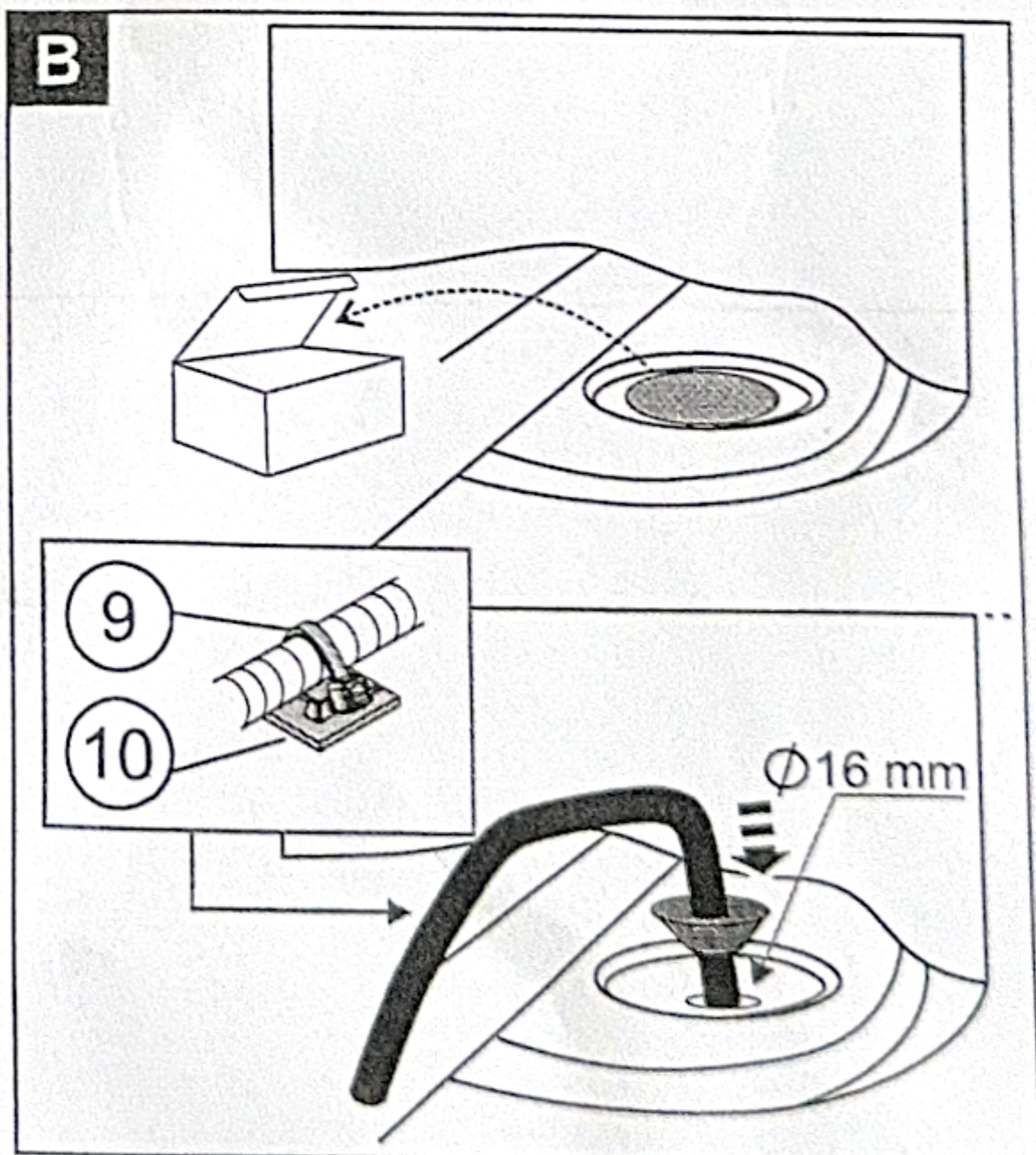
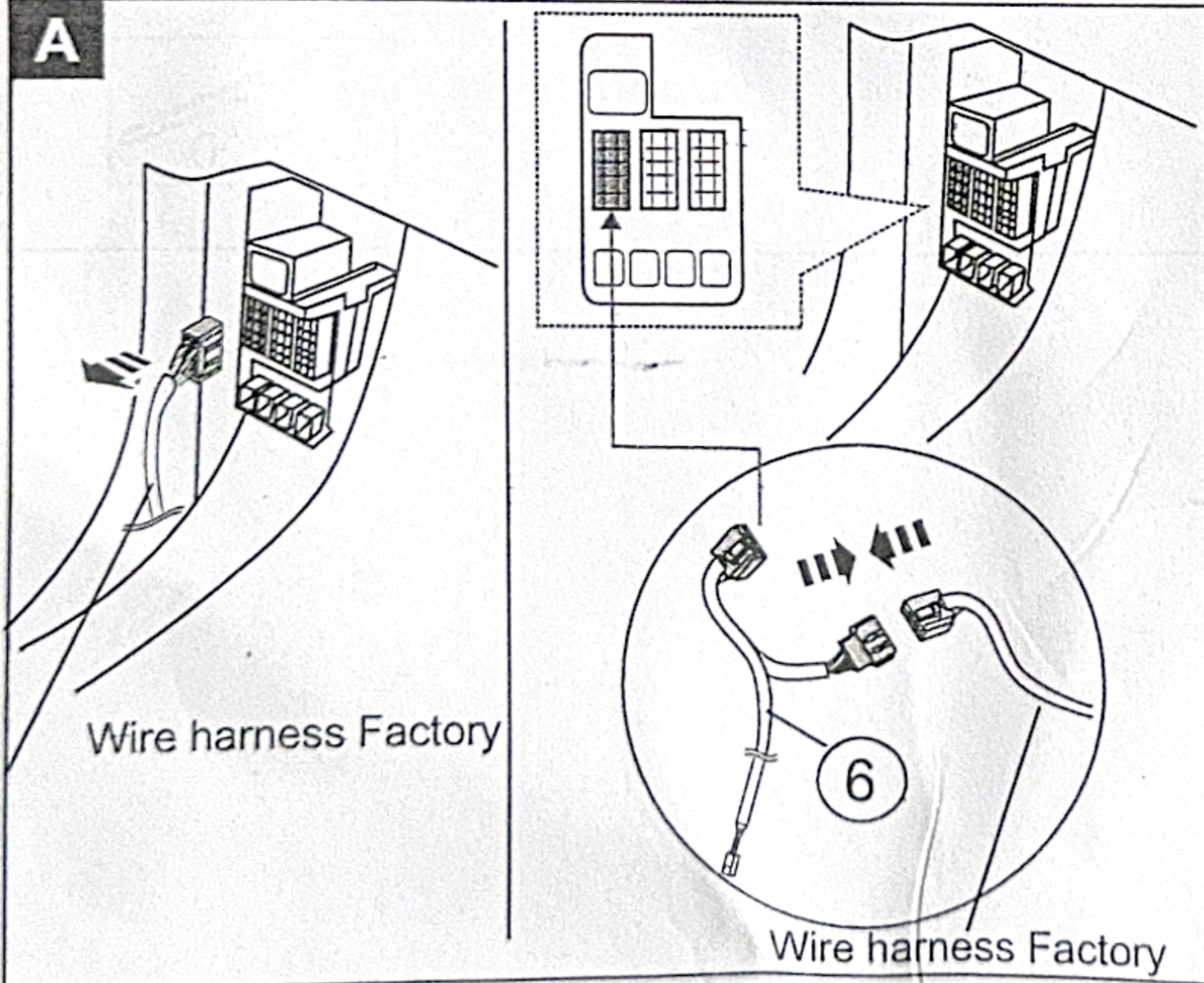
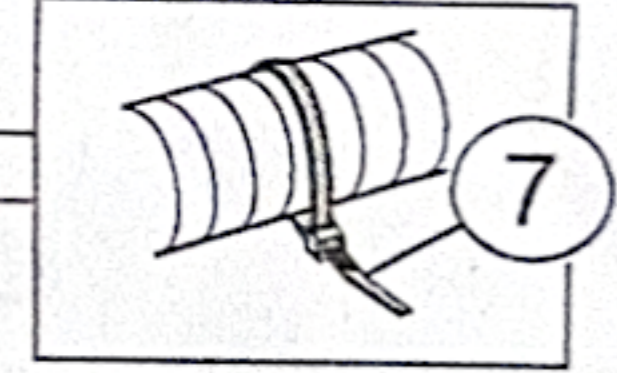
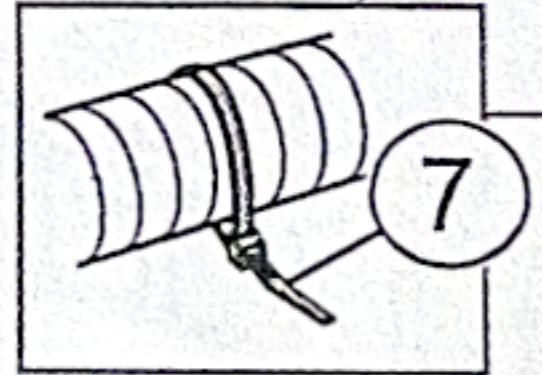
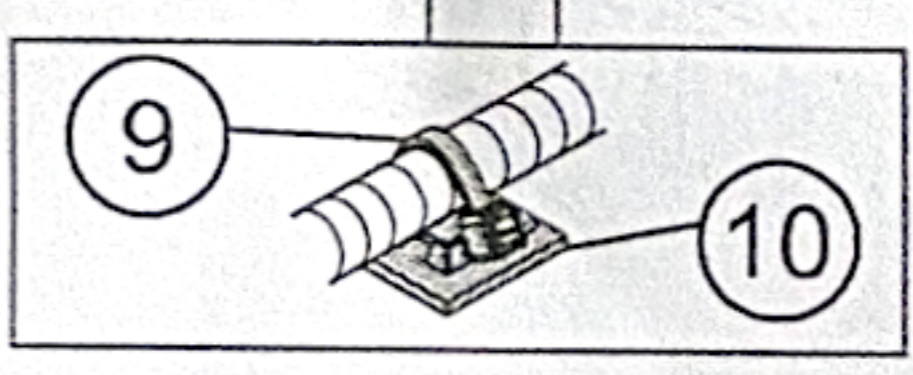
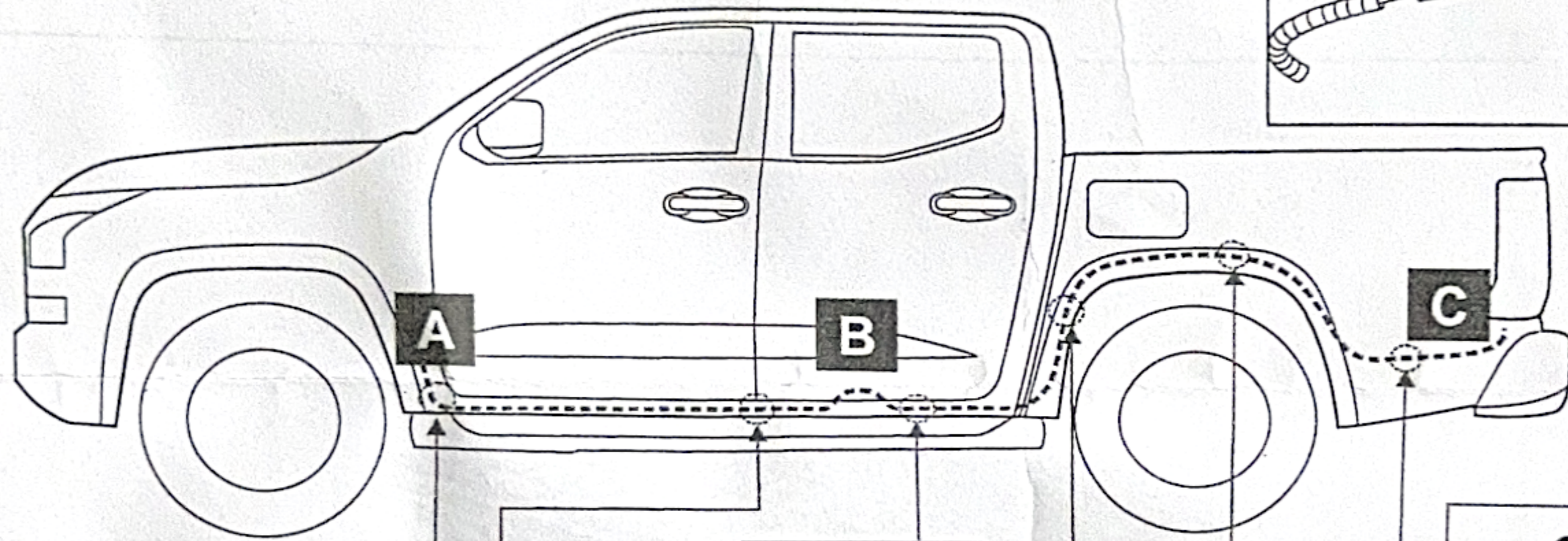
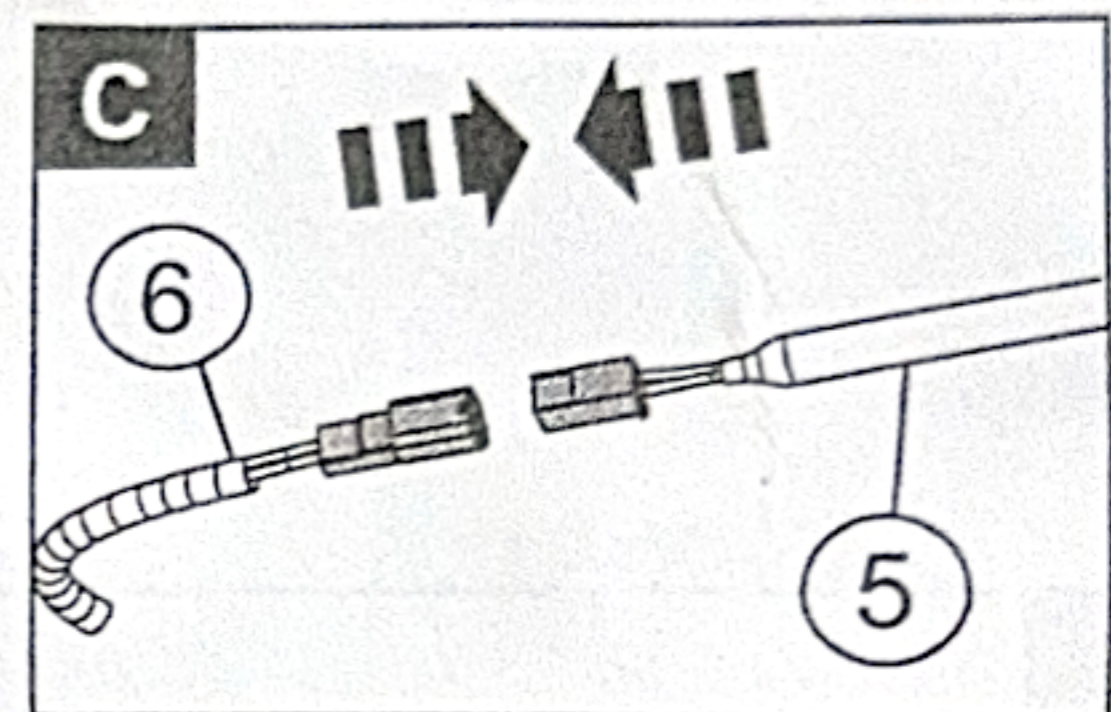
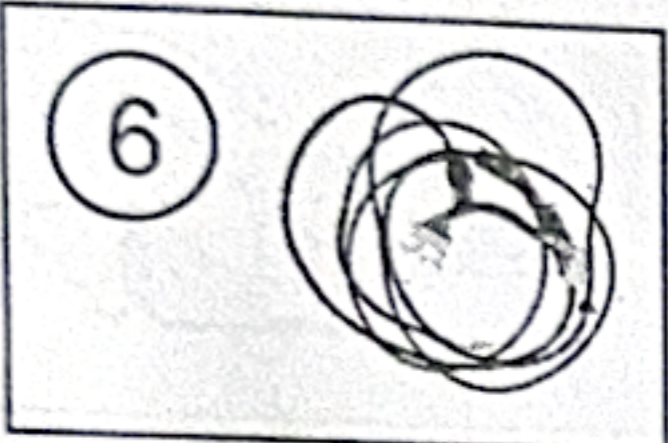

8

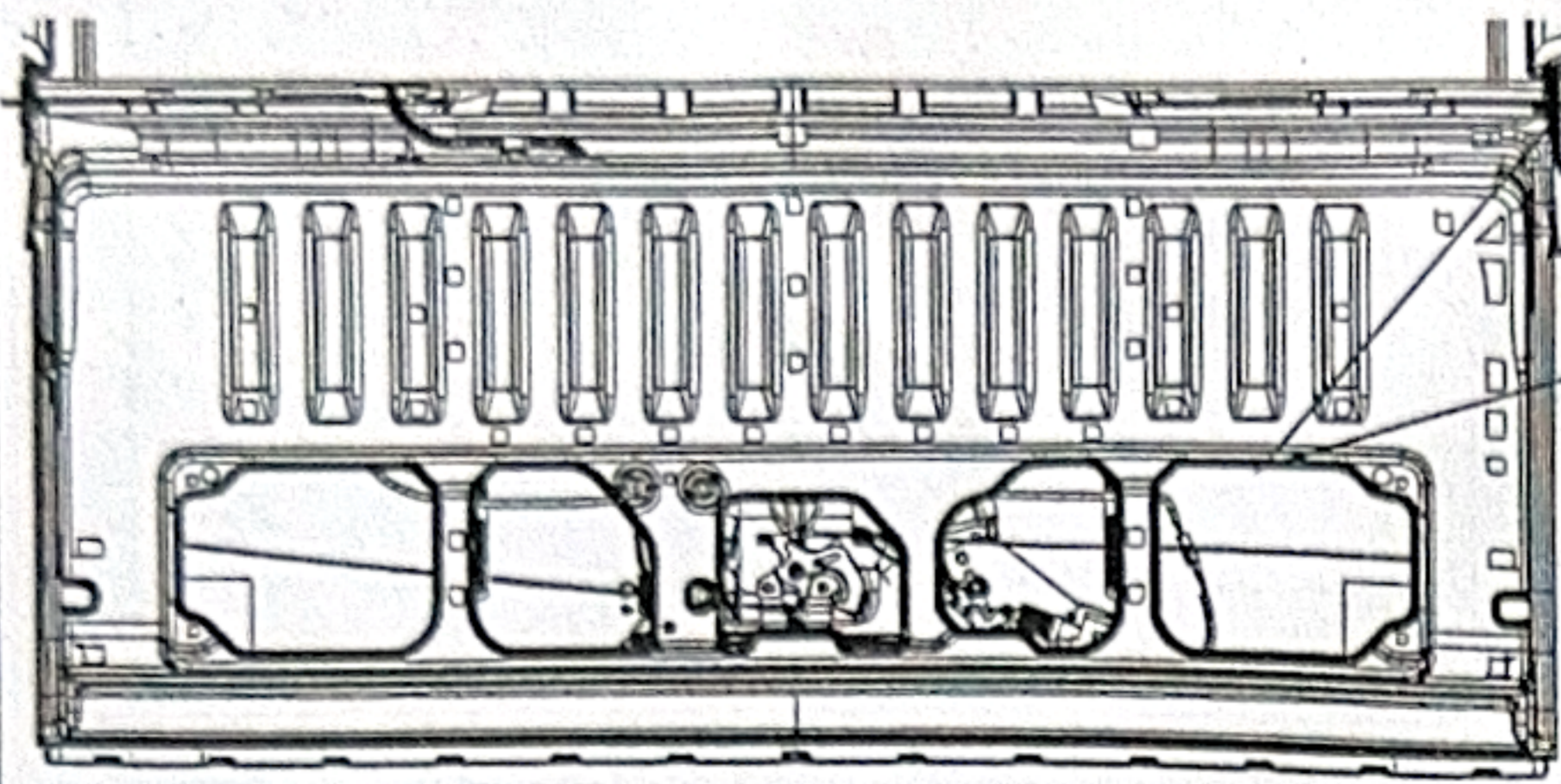

Tested by pressing the unlock and lock.

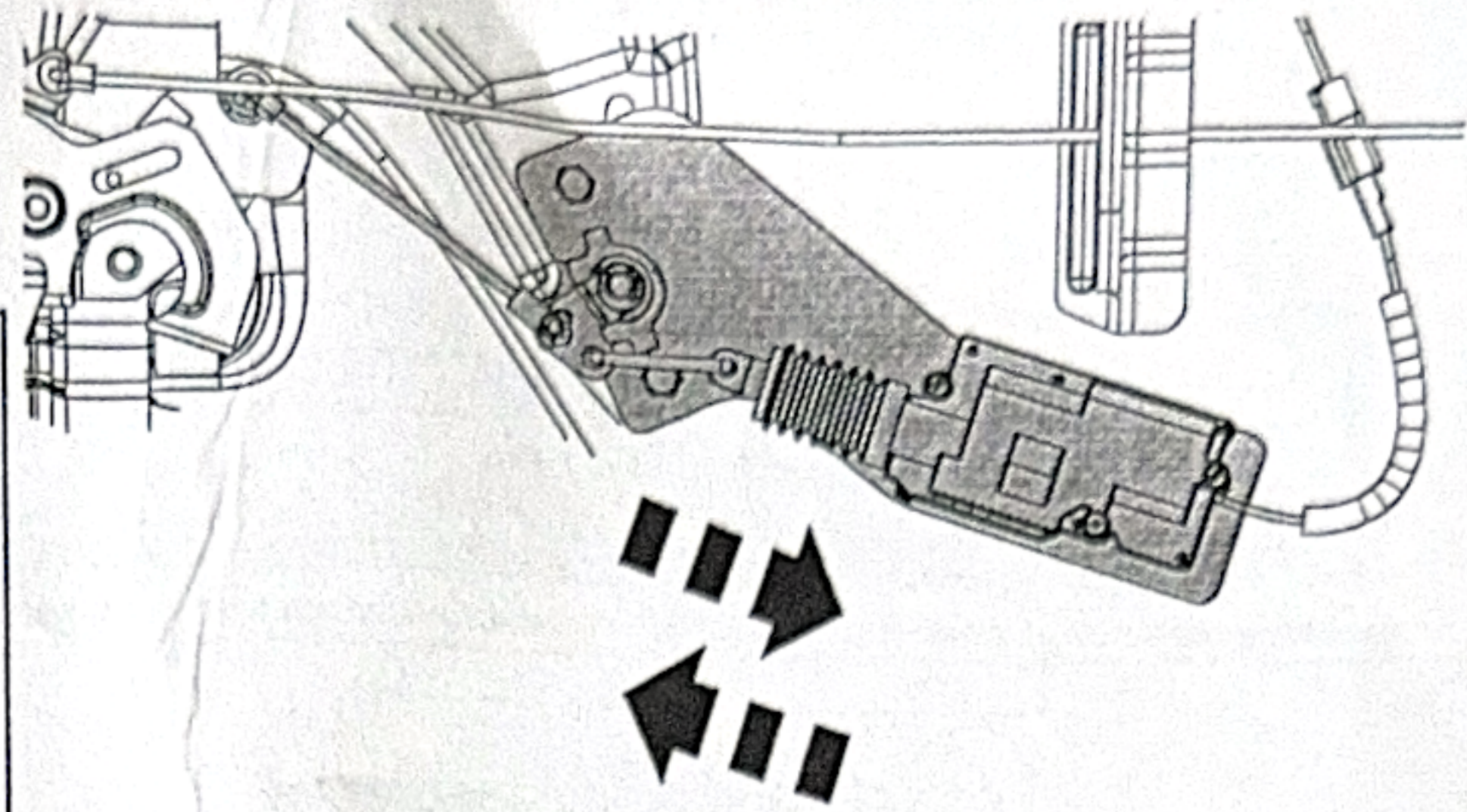

Check unlock/lock

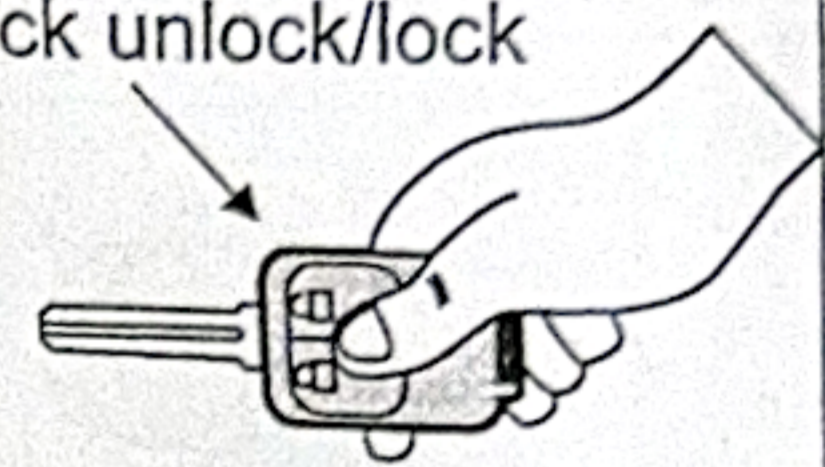

9

